



Speed Queen Homestyle Top Load Washer

LWN311SP541NW23

A proven performer

For more than a century Speed Queen has been focused on laundry, we know what it takes to deliver a machine with long-lasting strength, durability and performance like no other.

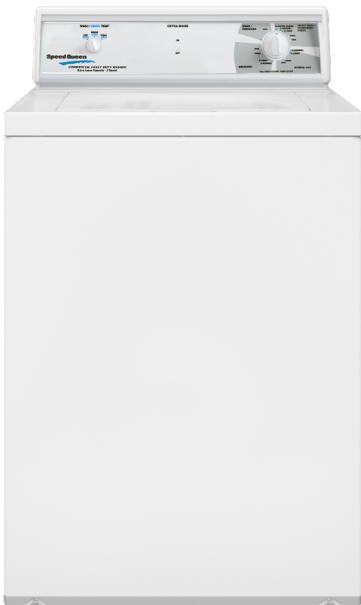

Built better to last longer

With a two-speed motor, the top load washer's 710 RPM maximum spin speed ranks among the highest in the industry, reducing drying times and handling high turnover volumes during peak periods. Our curved four-vane agitator delivers an industry-best 210° wash stroke, plus the new top panel wide-fan spray system rinses fabrics more evenly. It all adds up to unparalleled cleaning results. Speed Queen's exclusive stainless steel tub comes with a lifetime warranty, and actually becomes smoother with each use, so it won't pill, snag or fray clothes.

Commercial Grade Controls

Laundry is all we do, and we do it better than anyone else in the world. For decades, we've been designing, building and testing controls the same way we do our machines: for unmatched, longer-lasting performance. Tested to endure through virtually every event that typically causes malfunction, Speed Queen controls are durably designed to last in the harshest commercial environments — and last even longer in your home. We're so confident in our controls that we back our electronic models with an industry-best warranty on all parts and in-home labor.



Specifications

Speed Queen Homestyle Top Load Washer

Model	LWN311SP541NW23
General details	
Control	3 Cycle Mechanical
Control location	Rear
Actuation	None
Drum	
Capacity kg	15
Volume l	90,3
Drum speed	
G-factor	150
Extraction RPM	710
Power	
Motor power kW	0,37
Voltage	240/60/1
Cabinet	
Cylinder Finish	Stainless
Color	White
Door type	Solid
Connections	
Electrical requirements	240/60/1
Gas inlet connection mm	N/A
Water inlet	3/4"
Water Pressure kPa	1,4-8,3
Transport data	
Net weight kg	84
Shipping weight kg	89
Dimensions HxWxD mm	1092 x 711 x 651
Packed dimensions HxWxD mm	1143 x 762 x 711
Packed volume m3	0,62

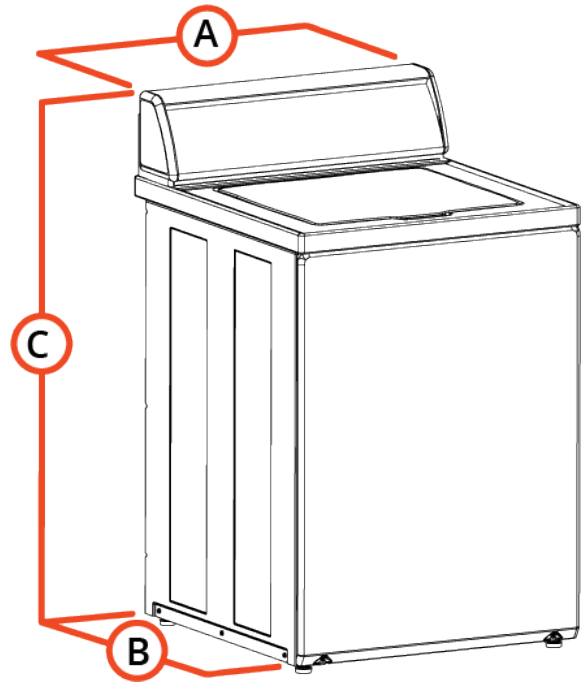

Dimensions

	mm
A	711
B	651
C	1092